



RICHTEK
your power partner.



产品选择指南

锂离子
供电应用的电源管理器件

Oct 2015

RICHTEK



微信扫一扫

立锜科技是一间国际级的模拟 IC 设计公司，我们专注于提供客户多元且具竞争力的产品以及完整的电源管理解决方案。自成立以来，立锜专注于整合技术能力、坚持质量和积极的客户服务，以提供客户产品价值为宗旨，产品广泛应用于电脑、消费性终端产品、网络通讯装置、大尺寸面板显示器等领域。立锜成立于公元 1998 年，总公司设立于台湾新竹，并且于亚洲、美国和欧洲各地有服务据点。

锂离子电池

供电应用的电源管理器件

Power Management Components for Lithium-Ion Battery Powered Applications

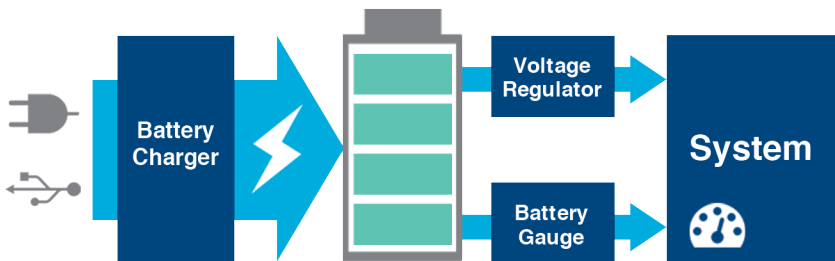

针对锂离子电池供电的应用，立锜科技拥有完整的电源管理解决方案，产品范围涵盖充电与保护、DC/DC 转换器和低耗电的线性稳压器。

锂离子电池应用设计

锂离子电池的优势

与其他电池类别相比，锂离子电池优势众多：

- 重量轻
- 没有记忆效应
- 与镍氢电池相比：
 - 有两倍的能量密度
 - 自放电率低 6~8 倍
- 3.6V 的单元电压可以满足众多应用的需要

这些特性使锂离子电池成为现今便携式电子产品的最常见选择。当使用锂离子电池进行应用设计时，最重要的是要理解它在充放电过程中的特性以确保应用的安全，同时保障使用时间的最优化。

电池的容量

图 1 所示的几种电池，容量在 200mAh~2800mAh 之间，可满足不同类型应用的需要。标准的锂离子电池一般使用硬壳封装，而离聚合物电池则常用软壳或是袋状封装，这可以减小尺寸和重量。

图 2 显示了容量为 2000mAh 的锂离子电池从充满电的 4.2V 放电到 3.0V 没电状态的典型放电曲线。放电率表示为电池容量的比率 (C)。在放电电流很高的情况下，电池容量不能得到充分的利用，电池电压因电池内阻而有比较大的下降。



图 1: 容量从 200mAh~2800mAh 的电池



图 2: 2000mAh 锂离子电池的典型放电曲线

用单节锂离子电池作为电源

当使用单节锂离子电池作为电源时，电池电压的波动是必须要考虑的，其值一般在 4.2V~3.0V 之间。大部分应用都需要使用稳定的电压作为电源，立锜科技就有很多 LDO、Buck、Boost 和 Buck-Boost 转换器可以在锂离子电池的电池电压范围内工作，为应用提供稳定的电压输出。

对使用锂离子电池的提示

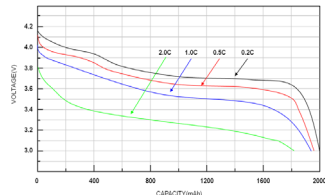
锂离子电池对过放电是比较敏感的，这是为什么电池包里面都要装入欠压保护电路以便在电池电压因放电而降低到 2.5V 时将电池从电路中断开的原因。电池应当在电池内部的保护电路被激活以前就被再次充电或是断开和系统的连接。

假如电池有很长一段时间没有被使用，最好是将它放电到其容量还剩余 40%（约 3.7V）以后再使用，这可以降低对其寿命的影响。

锂离子电池 应用中的开关式和线性调节器

产品概览

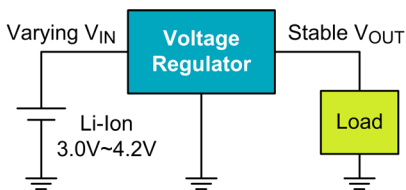

立锜科技的大部分开关式调节器都有轻载效率提升的设计，可以扩大电池的使用空间。

Boost 转换器，例如 [RT9276](#)，可将变换的电池电压转化为稳定的 5V 输出为 USB 端口供电，它还具有电压监控功能。Buck-Boost 调节器，例如 [RT6150A/RT6154A](#)，能在输入电压高于或低于

输出电压时输出稳定的电压，因为它能借助内部集成的 4 个开关自动在 Buck 或 Boost 之间自动切换。大多数低压 Buck 转换器都有工作在 100% 占空比的能力，可在电池电压逼近输出电压时输出稳定的电压，增加电池的使用时间，其例子如 [RT8059](#)。低耗电的 LDO，例如 [RT9063](#)，最适合在低功耗的应用中输出稳定的电压，1 μ A 的地电流消耗可使低功耗的待机状态消耗最小化。

升压转换器

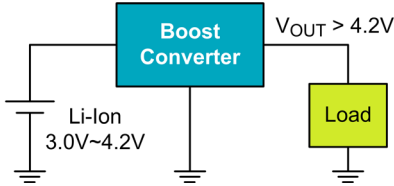

- 低 EMI
- 输出电压最高达 45V
- 附加检测功能
- 轻载高效

V _{OUT}	I _{SW_MAX}	产品描述	关键特性	型号
Up to 5V	2A	Synchronous Boost Converter with Bypass mode	<ul style="list-style-type: none"> → Low BOM solution with small external components → Smooth transition between boost mode and bypass mode → Less than 1μA quiescent current in shutdown mode → I²C control to optimise target V_{OUT} → WL-CSP-16B 1.67x1.67 (BSC) package 	RT4803A
Up to 5.5V	2A	Synchronous Boost Converter with current limit control	<ul style="list-style-type: none"> → CMCOT topology for fast transient response → Small output ripple when V_{IN} is close to V_{OUT} → Adjustable 1A/2A, two level current limit threshold → PSM for enhanced light load efficiency → TSOT-23-8 package 	RT4812
Up to 6.5V	1.6A	Synchronous Boost Converter with LDO Controller	<ul style="list-style-type: none"> → For All One-Cell, Two-Cell and Three-Cell Alkaline, NiCd, NiMH and Single-Cell Li+ batteries powered applications → True load disconnection during shutdown to extend battery power 	RT9296
		Synchronous Boost Converter with Voltage Detector	<ul style="list-style-type: none"> → Output voltage is monitored by a PGOOD signal → Enhanced light load efficiency at power save mode → Low EMI → WDFN-10L 3x3 package 	RT9276 Sample
Up to 16V	1.6A	PWM Asynchronous Boost Converter	<ul style="list-style-type: none"> → Component size or efficiency consideration by optional 640kHz/1.2MHz operation frequency 	RT9277B
		PSM Asynchronous Boost Converter	<ul style="list-style-type: none"> → Internal or External programmable Soft-Start → Loop responses can be optimized by external compensation 	RT9277C
Up to 24V	3.0A	Asynchronous Boost Converter	<ul style="list-style-type: none"> → MSOP-8, WDFN-8L 3x3 and WDFN-10L 3x3 packages → Small package and PCB footprint → 550kHz operation frequency → Internal power N-MOSFET switch → Supports up to 10 WLED strings → PWM-Analog dimming (RT4503A) → 32 step pulse dimming (RT4503A) → WDFN-6L 2x2 package 	RT9297
Up to 36V	1.2A	Asynchronous Boost Converter	<ul style="list-style-type: none"> → Small package and simple external circuit design → 1MHz operation frequency → Internal power N-MOSFET switch → Supports up to 10 WLEDs for backlighting and OLED power application → TSOT-23-6 and WDFN-8L 2x2 packages 	RT4503/A
Up to 45V	1.0A	Asynchronous Boost Converter	<ul style="list-style-type: none"> → Small package and simple external circuit design → 1MHz operation frequency → Internal power N-MOSFET switch → Supports up to 10 WLEDs for backlighting and OLED power application → TSOT-23-6 and WDFN-8L 2x2 packages 	RT9293

升 - 降压转换器

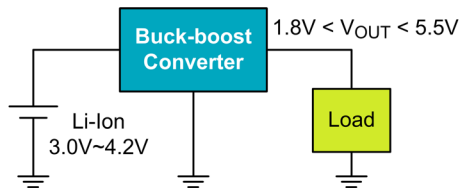

- Seamlessly switching between Buck and Boost mode
- Power save mode enable control
- Support up to 5A peak current (3A max load capability)

V _{OUT}	I _{SW_MAX}	产品描述	关键特性	型号
1.8V ~ 5.5V	1.6A	Current Mode Buck-boost Converter	<ul style="list-style-type: none"> → Up to 90% efficiency → Fixed frequency at 1MHz → WDFN-10L 3x3 and WDFN-10L 2.5x2.5 package 	RT6150A/B
		Current Mode Buck-boost Converter	<ul style="list-style-type: none"> → Up to 96% efficiency → Fixed frequency at 2.4MHz → Can be synchronized to external clock 2.2MHz to 2.6MHz for low interference solution → WDFN-14L 4x3 package 	RT6154A/B

降压转换器

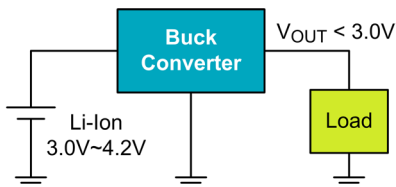

- Low profile and small footprint
- Up to 95% Efficiency
- No Schottky diode required 100% duty-cycle mode

V _{OUT}	I _{OUT}	产品描述	关键特性	型号
0.5V ~ V _{IN}	0.4A	1.25MHz Buck Converter	<ul style="list-style-type: none"> → PSM enhanced light load efficiency → SOT-23-5 / TSOT-23-5 packages 	RT8025 Sample
0.6V ~ V _{IN}	0.6A	1.5MHz Buck Converter	<ul style="list-style-type: none"> → PSM enhanced light load efficiency → SOT-23-5 / TSOT-23-5 packages 	RT8008 Sample
		1.5MHz Buck Converter	<ul style="list-style-type: none"> → PWM mode / low-dropout auto switch and shutdown mode → Auto discharge function → 0.5mm height low profile, ideal for applications with height limitations → UDFN-6L 1.6x1.6 packages 	RT8099
0.6V ~ V _{IN}	1.0A	1.5MHz Buck Converter	<ul style="list-style-type: none"> → PSM enhanced light load efficiency → WDFN-6L 2x2 package 	RT8016 Sample
0.6V ~ V _{IN}	1.0A	2.25MHz Buck Converter	<ul style="list-style-type: none"> → 2.25MHz high operating frequency for reducing external component size → PWM operation → TSOT-23-5 / WDFN-6SL 2x2 packages 	RT8057A
		1.5MHz Buck Converter	<ul style="list-style-type: none"> → PWM enhanced light load efficiency → TSOT-23-5 package 	RT8059
0.6V ~ V _{IN}	1.0A	1.5MHz Buck Converter	<ul style="list-style-type: none"> → PWM mode / low-dropout auto switch and shutdown mode → WDFN-6L 2x2 package 	RT8080 Sample

双通道降压转换器

V _{OUT}	I _{OUT}	产品描述	关键特性	型号
0.6V ~ V _{IN}	1A + 1A	Dual Buck Converter	→ 50μA Quiescent Current per channel → 1.5MHz Fixed frequency PWM operation → WDFN-12L 3x3 package	RT8020 Sample
0.8V ~ V _{IN}	1A + 1.5A	Dual Buck Converter	→ Power Good output voltage monitor → 1.2MHz Fixed frequency PWM operation → WQFN-16L 4x4 package	RT8012A Sample

特殊及低静态电流 LDO

通用性 LDO

V _{IN}	V _{OUT}	I _{OUT}	I _Q	关键特性	型号
2.5V ~ 5.5V	1.5V ~ 5.0V	300mA	90μA	→ Auto discharge function → SC-70-5, SC-82, SOT-23-3, SOT-23-5, TSOT-23-3, TSOT-23-5, MSOP-8, & WDFN-6L 2x2 packages	RT9198
2.5V ~ 5.5V	1.5V ~ 5.0V	300mA	90μA	→ Bypass pin for ultra low noise → Auto discharge function → SC-70-5, SOT-23-5, TSOT-23-5, MSOP-8 & WDFN-6L 2x2 packages	RT9193

特殊 LDO

V _{IN}	V _{OUT}	I _{OUT}	I _Q	关键特性	型号
2.2V ~ 5.5V	1.2V ~ 3.3V	500mA	25μA	→ Auto discharge function: 5mA discharge current of V _{OUT} when shutdown → SOT-23-5 & SC-70-5 packages	RT9020
1.5V ~ 5.5V	0.9V ~ 3.5V	300mA + 300mA	29μA + 29μA	→ Dual LDO regulator → In tiny CSP package → WL-CSP-6B 0.8x1.2 package	RT9055

超低静态电流 LDO

V _{IN}	V _{OUT}	I _{OUT}	I _Q	关键特性	型号
2.0V ~ 6.0V	1.2V ~ 5.0V	100mA	4μA	→ TO-92, SOT-89, SOT-23-3 & SOT-23-5 packages → With enable pin active high → SOT-23-5 package	RT9169 Sample RT9169H
2.5V ~ 6.0V	1.2V ~ 3.3V	200mA	1μA	→ SOT-23-3 & SOT-89-3 packages	RT9063
1.2V ~ 5.5V	0.9V ~ 3.3V	250mA	1μA	→ SOT-23-5, SC-70-5 & SC-82 packages → With EN pin	RT9073

电池管理产品

锂离子电池的充电

锂离子电池的充电是个精细活，过度的充电可能导致不安全的状况。大多数充电器都具有预充、恒流充、恒压充、充电截至和自动复充的功能，这些功能在图 3 中予以显示。



图 3：锂离子电池充电模式

对于深度放电的电池，充电器会在第一时间启用小电流的预充模式对电池的状态进行调整，使之可以接受正常的充电操作。这种小电流预充也可以起到重启内部欠压保护电路的作用。

在恒流充电期间，电池按照额定的充电电流进行充电。当电池电压升高至接近充电器件的调整电压（根据电池类型不同，可为 4.2V 或 4.35V）时，充电进入恒压模式，充电电流也逐渐减少。最高的调整电压是需要进行精确控制的，过高的充电电压可能导致电池的损坏，甚至可能造成不安全的状况。

当电池电压已经与充电电压相等且充电电流下降至额定充电电流的某个百分比以下时，电池就可以被认为已经充满，充电过程将终止。对于锂离子电池来说，持续进行的涓流充电是不建议使用的，这将导致电池寿命的缩短。大多数充电器件会在电池电压跌落至某个水平（一般是低于充满电压 0.1V~0.2V）时重启充电过程。

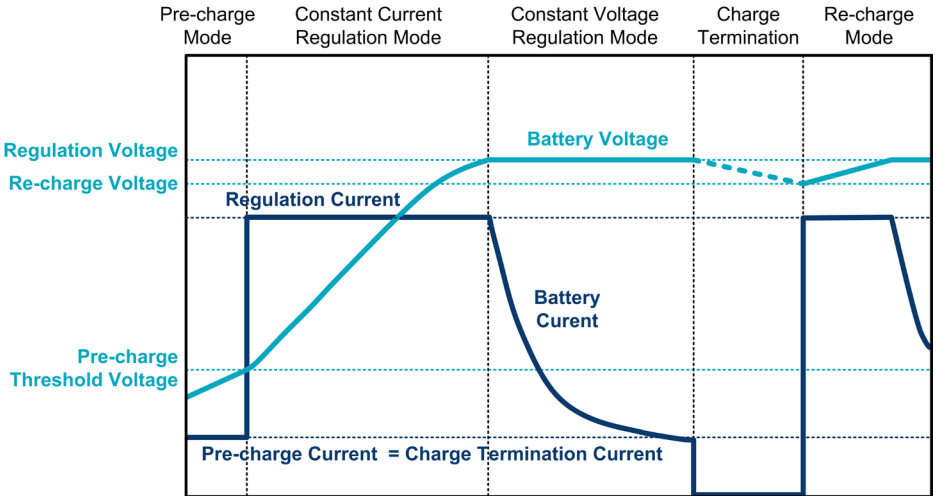
假如锂离子电池长期未被使用，最好是将其放电至 40%（约 3.7V）以后再充电以避免降低其寿命。

充电期间的电池温度需要受到监控，当温度过高、过低时应当停止充电过程。对于大多数锂离子电池来说，能够以正常参数进行充电的温度范围是 10°C ~ 45°C。如果温度低于 0°C 或高于 60°C，则充电就应该终止。

电池管理器件的选择

立锜科技的锂离子电池充电 IC 产品众多，其工作方式分为线性方式和开关方式。线性方式充电器件可用于容量高达 1000mAh 的锂离子电池，更大容量的电池就最好使用开关方式的充电器件了，它们可使用更大的电流 (>1A) 进行充电，同时也容许使用电压较高的电源适配器。

线性充电器

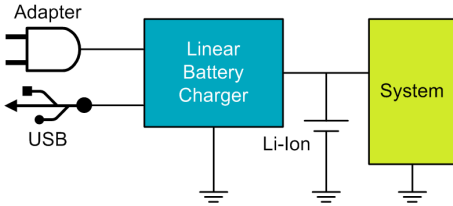

- Ideal for 1000mAh batteries
- Up to 1.2A current charger ICs
- Auto power path management

AC / USB 双输入充电器

产品描述	关键特性	型号
1.2A Linear Single Cell Li-ion Battery Charger	<ul style="list-style-type: none"> → Automatic input supplies selection between AC and USB → Integrated selectable 100mA and 500mA USB charge current and 1A AC adapter charge current → NTC sense for battery temperature monitor → AC Power Good and charge status indicators → WDFN-10L 3x3 package 	RT9502 Sample
1.2A Linear Single Cell Li-ion Battery Charger with Input Over Voltage Protection	<ul style="list-style-type: none"> → Cost effective solution → 28V(max) input rating for AC adapter → Power good and charge status indicators → Programmable charging current → Adjustable end-of-charge(EOC) current → Thermal feedback optimizing charge rate → WDFN-8L 2x3 & SOT-23-6 package 	RT9526A
1.2A Linear Single Cell Li-ion Battery Charger with 4.9V/50mA LDO	<ul style="list-style-type: none"> → 28V(max) input rating for AC adapter → 4.2V/2.3A factory mode → 50mA LDO to support the power of peripheral circuit → Programmable charging current → Integrated selectable 100mA and 500mA USB charge current → Power good and charge status indicators → WDFN-10L 3x2 package 	RT9532 Sample RT9536

内置自动电源路径管理 (Auto Power Path Management) 系列

自动电源路径管理特性赋予应用系统直接从适配器获得电源的特性，而且还能在适配器供电不足时自动将电池纳入供电源行列，通常这种器件也具有更多的保护功能，如输入过压保护、输出短路保护和负载断开功能。

产品描述	关键特性	型号
1.2A Linear Single Cell Li-ion Battery Charger with Auto Power Path Management and System Off	<ul style="list-style-type: none"> → 28V(max) input rating for AC adapter → Auto Power Path Management(APPM) with system off → Adjustable Power current limit 0.1/0.5/1.5A → NTC sense for battery temperature monitor → Power good and charge status indicators → WQFN-16L 3x3 package 	RT9525 Sample
1.2A I ² C Linear Single Cell Li-ion Battery Charger with Auto Power Path Management and USB/AV Switch	<ul style="list-style-type: none"> → 28V(max) input rating for AC adapter → Integrated 3.3V LDO for NTC sense circuitry → Auto Power Path Management(APPM) → USB/Audio/Video switches → Termination, timer, charge current and VSYS settings through I²C → Interrupt status, power good and charge status indicators → WQFN-28L 4x4 package 	RT9528

开关式充电器

拥有 I²C 控制接口的开关方式充电 IC 具有众多功能，容许系统对充电参数和过程进行灵活的控制。部分集成了 MOSFET 开关的器件还容许被设定为 Boost 工作模式，可将电池电压提升至 5V 回送至 V_{IN} 端，这恰好满足了 USB-OTG (On The Go) 应用的需求。

锂离子电池充电器

产品描述	关键特性	型号
1.5A, I ² C Switch-Mode Single Cell Li-Ion Battery Charger with USB On-The-Go (OTG)	→ 4V-6V Input voltage	RT9450A
	→ Synchronous 3MHz fixed frequency with up to 99.5% duty cycle	
	→ Ideal for 2000mAh battery capacity	
1.55A, I ² C Switch Mode Single Cell Li-ion Battery Charger with USB-OTG	→ 4.3V-6V Input voltage	RT9455
	→ Synchronous 1.5MHz fixed frequency with up to 95% duty cycle	
	→ State machine controls via IRQ output	
	→ Ideal for 2,000mAh battery capacity	
	→ All charge parameters can be executed via the I ² C interface	
4.0A, I ² C Switch Mode Single Cell Li-ion Battery Charger with USB-OTG	→ WL-CSP-16B 1.7x1.77 package	RT9451
	→ 4.3V-12V Input voltage	
	→ Synchronous 375kHz fixed frequency with up to 99.0% duty cycle	
	→ USB OTG mode boosts the battery voltage to 5V and provides up to 1.6A current to the USB input	
	→ Ideal for 2,000mAh ~ 4,000mAh capacity batteries	
→ All charge parameters can be executed via the I ² C interface		
	→ WQFN-32L 4x4 package	

通用型充电器

产品描述	关键特性	型号
2A Asynchronous Switch Mode Battery Charger	→ 4.5V-28V input voltage	RT9535A
	→ Adjustable battery voltages from 2.5V-22V	
	→ Internal Power MOSFETs	
	→ 500kHz switching frequency	
	→ NTC sense for battery temperature monitor	
2A Asynchronous Switch Mode Battery Charger	→ WQFN-16L 4x4 package	RT9538
	→ 4.5V-28V input voltage	
	→ Adjustable battery voltages from 2.5V-25V	
	→ External Power MOSFETs	
	→ Input current limit maximizes charging rate	
	→ 475kHz switching frequency	
	→ Flag indicates Charging status	
→ WQFN-16L 4x4 package		

电池电量计

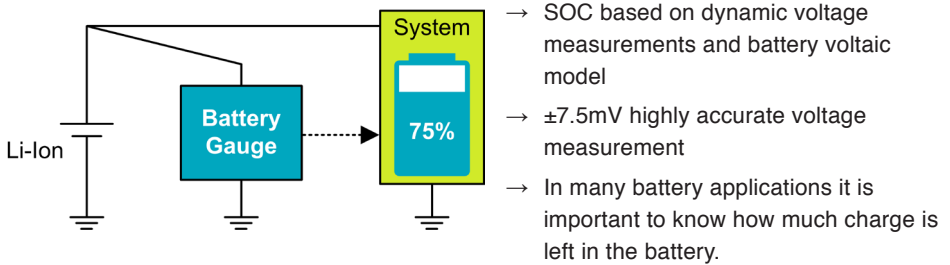

库伦计数法 — 传统的电量计

了解电池充电状态 (SOC) 的传统方法是库伦计数法。从理论上来说，这种方法是精确的，但却饱受时间累计误差之苦。这种方法的成本也高，因为它必须使用电流检测电路。

立锬的新方案

基于动态电压测量的电池容量算法是一种全新的方法，它利用实时测量的电池电压结合电池的动态模型对电池储能状况进行计算，没有误差累积效应，这种方法被使用在立锬的电量及产品 **RT9420** 和 **RT9428** 中。

这些 IC 在系统中和电池连接在一起对电池电压进行精确的测量，内置在 IC 中的算法对电池容量状况进行计算，计算结果通过 I²C 总线发送给系统控制器。

为了进行精确的 SOC 计算，系统所用电池的数学模型需要在设计阶段就要被了解清楚，由温度和充 / 放电过程所带来的效应都会被涵盖在其中。

产品描述	关键特性	型号
I ² C Host-side Single Cell Li-ion Battery gauge	→ ±3% State-of-Charge (SOC) error under general charging/discharging	RT9420
	→ Precise voltage measurement ±12.5mV accuracy	
	→ Accurate relative capacity(RSOC) calculated from Voltaic Gauge algorithm with temperature compensation	
	→ No accumulation error on capacity calculation	
	→ No battery relearning necessary and no current sense resistor required	
I ² C Host-side Single Cell Li-ion Battery gauge	→ WDFN-8L 2x3 package	RT9428
	→ ±3% State-of-Charge (SOC) error under general charging/discharging	
	→ Precise voltage measurement ±7.5mV accuracy	
	→ Accurate relative capacity(RSOC) calculated from Voltaic Gauge algorithm with temperature compensation	
	→ No accumulation error on capacity calculation	
I ² C Host-side Single Cell Li-ion Battery gauge	→ No battery relearning necessary and no current sense resistor required	WL-CSP-8B 1.6x1.52 (BSC) package
	→ WL-CSP-8B 1.6x1.52 (BSC) package	

EZPBS™ 移动电源解决方案



- EZPBS™ highly integrated single chip solution
- Ideal for 3,000mAh battery capacity

产品描述	关键特性	型号
EZPBS™ Integrated Chip with Two Ports Output	→ Easy-to-use Power Bank Solution (EZPBS™)	RT9480
	→ Compact BOM elements with EZPBS™ single chip	
	→ Support charging and discharging at the same time by smart algorithm	
	→ 1.2A linear charger, asynchronous Boost with dual output load management and a torch function support included	
	→ Support dual USB output (Total 2.5A)	
	→ Support one sync-boost up to 2.5A	
4.0A, I ² C Switch Mode Single Cell Li-ion Battery Charger with USB OTG	→ Battery state of charge(SoC) indicator by 4LEDs	RT9451
	→ WQFN-24L 4x4 package	
EZPBS™ Integrated Chip with Switch Charger	→ Provide up to 1.6A USB output current in OTG mode for power bank	RT9481
	→ WQFN-32L 4x4 package	
	→ Easy-to-use Power Bank Solution (EZPBS™)	
	→ Built-in USBOUT DCP Controller, Attach/ Detach Detection, Light Load Detection	
	→ Built-in Adapter Detection with BC1.2	
	→ Charge Voltage Regulation form 3.65V to 4.6V	
	→ Charge Current Regulation form 0.7A to 2.7A	
	→ All charge parameters can be executed via the I ² C interface	
→ 750kHz switching frequency		
	→ Current Regulation of Load Switch for 3A	
	→ WQFN-24L 4x4 package	

Wireless Power Receiver Solution

Robust and flexible WPC Qi compliant 7.5W wireless power receiver

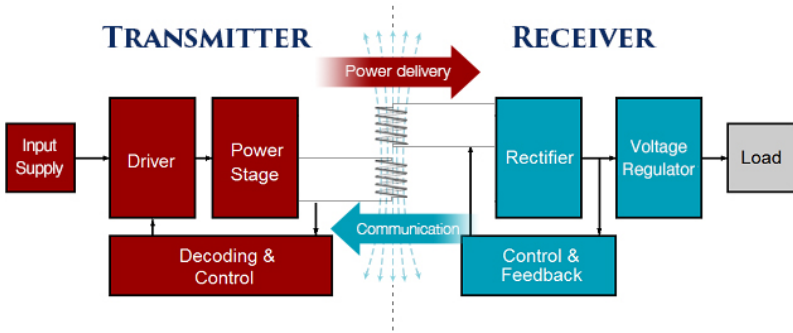

产品描述	关键特性	型号
Wireless power receiver	<ul style="list-style-type: none"> → Highly integrated with on-board 32-bit ARM-Cortex-M0 MCU → Very flexible with a user configurable MTP memory → Compliant with the WPC1.1 for low power up to 5W and WPC1.2.0 for medium power up to 7.5W → A high efficiency fully synchronous rectifier stage and a low drop 1.5A linear post regulator stage → A special headroom control system regulates the LDO headroom for optimal balance between transient response and system efficiency up to 80% → Supporting both adapter input and wireless power transfer input → CSP 3.0mmx3.4mm 48B (pitch=0.4mm) in 0.55mm low profile 	RT1650

Find out more in the [application note](#) for the basic principles of Wireless Power Transfer, Wireless Power standards and the Qi WPC1.1 low power standard, and a practical example of the WPC1.1 5W application where a Nokia DT601 wireless power transmitter is paired with the wireless power receiver RT1650 evaluation board.

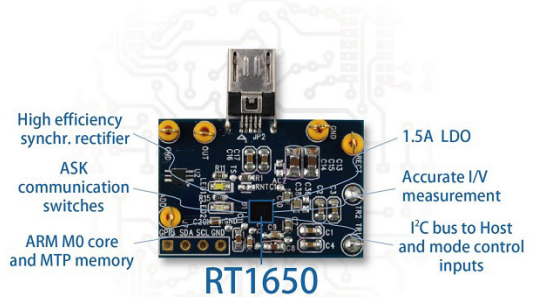

前端保护 IC

RT9718 是全集成的用于保护使用锂离子电池供电的系统免受高达 28V 非正常电压攻击的保护电路。

RT9718 对输入电压、电池电压和输入电流进行监控。在输入电压超出过压保护电压时，RT9718 将在 1 μ s 内断开 MOSFET，以避免在可能的危害发生前将电源移除。另外，RT9718 可以在电池不存在的情况下为系统提供电压输出。

产品描述	关键特性	型号
28V Over Voltage Protection IC	<ul style="list-style-type: none">→ Fully integrated protection function: programmable OCP, input OVP and battery OVP→ Over voltage turn off time less than 1μs→ High accuracy protection threshold→ WDFN-8L 2x2 package	RT9718

设计资源

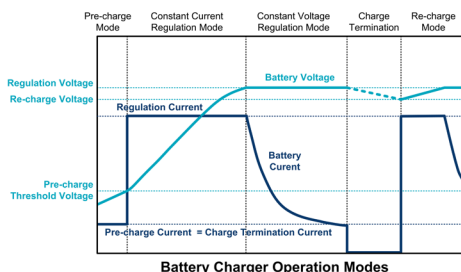

锂离子电池管理中的问题与解决方案

郑刚, 项目经理

锂离子 / 聚合物电池（以下均简称锂离子电池）是以锂合金的金属氧化物为阳极材料、以石墨为阴极材料、使用非水电解质的可充电电池。根据阳极所用材料的不同，不同种类的锂离子电池也表现出不同的特性，它们最明显的电特性上的差异就表现在不同的公称电压上，与之相应的充电终止电压和放电截止电压也各自不同 ...



<http://www.richtek.com/Design Support/Technical Document/AN023>

基于锂离子电池的应用设计

Roland van Roy, 资深 FAE

与其它类型的二次电池相比，锂离子电池具有以下优点：重量轻，其能量密度是镍 - 镉电池的两倍；自放电比镍 - 镉电池少 6 ~ 8 倍；没有记忆效应；单元电压大约 3.6 伏，属于较高水平，通常能满足大多数应用的需要。这些特点让锂离子电池在便携式电子产品中得到广泛的应用 ...



<http://www.richtek.com/Design Support/Technical Document/AN025>

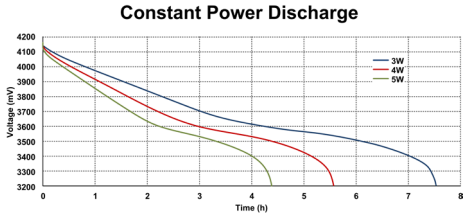

锂离子電池及電池電量計介紹

何昌祐, RD 處長

電池管理可視是為電源管理的一部分。電池管理中，電量計是負責估計電池容量。其基本功能為監測電壓，充電 / 放電電流和電池溫度，並估計電池荷電狀態 (SOC) 及電池的完全充電容量 (FCC)。有兩種典型估計電池荷電狀態的方法：開路電壓法 (OCV) 和庫倫計量法。另一種方法是由 RICHTEK 所設計的動態電壓算法 ...



http://www.richtek.com/Design_Support/Technical_Document/AN024

大公開 - 自己做一个安全与效能兼具的行動電源

如何自己做一个安全又高效的移动电源？目前流行的自造移动电源 DIY，要如何挑选核心的行动电源控制芯片？最重要的是芯片的保护功能、转换效率。立锜科技 RT9480 EZPBS™ 电源控制芯片 ...



http://v.youku.com/v_show/id_XMTM10DgwMjgyNA==.html

Module Parameter	Status	Vin (min) (V)	Vin (max) (V)	Number of Outputs	Vout (min) (V)	Vout (max) (V)	Fixed Vout Option (V)	Output Adj. method	Accuracy (%-%)	Iout (max) (A)	η (Typ) (%)
Total Parts: 15											
Matching Parts: 15											
Match Part Order											
Parametric Selection Controls	Active										
Filter All Parameters											
TIPO01: Dual Low-Dropout Regulator with precision	Active	2.5	5.5	2	1.5	3.3	1.8, 2.5, 2.8, 3.3, 3.5, 4.5	Fixed	2	0.24	0.03
TIPO02: Dual Low-Dropout Regulator with precision	Active	2.5	5.5	2	1.5	3.3	1.8, 2.5, 2.8, 3.3, 3.5, 4.5	Fixed	2	0.24	0.03

器件参数搜索引擎



依需求搜寻符合条件的 IC

http://www.richtek.com/Parametric_Search/Parametric_Search?tree_ID=27



无线充电应用大公开：点亮你的无线 LED 灯

视频中介绍了无线充电的原理，并列出了立锜晶片 RT1650 的应用。RT1650 是符合 Qi 标准的无线电源接收端，功率最高可达 7.5W。



http://v.youku.com/v_show/id_XMTM0MTk0NzQ5Mg==.html

RICHTEK

立錡科技股份有限公司 TEL:886-3-5526789 FAX:886-3-5526611 (Headquarters)

Taipei Office

TEL:886-2-89191466

FAX:886-2-89191465

Shanghai Office

TEL:86-21-66798688

FAX:86-21-66798699

Shenzhen Office

TEL:86-755-88353955

FAX:86-755-88353947

Beijing Office

TEL:86-10-64742610

FAX:86-10-64742615

www.richtek.com

